



Accsoon CoMo

讯声

User Manual
用户手册

contents

01		Packaging List	06		Product Features
06		Product Description		
06		Instruction		
06		Accsoon CoMo	08		Volume control
08		First use	10		Indicator status and voice prompt
.....					
11		Specifications	14		After sales
12		FAQ	15		Safety Information
14		Warranty	15		Contact Us

目录

19		包装内容	24		产品特征
24		产品简述		
24		使用说明		
24		认识产品	27		声音调整
26		使用	28		耳机状态与提示音
.....					
29		参数表格	32		售后说明
30		常见问题	32		安全信息
32		质保说明	33		联系我们

1、Packaging list

Accsoon CoMo (1 host headset, 8 remote headsets) package includes:

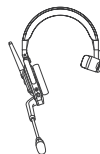

Host Headset × 1



Remote headset × 8



Battery × 18

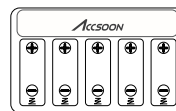

Battery charger × 2



Battery storage box × 3

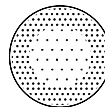

Headset ear cushion × 9

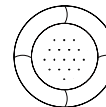

Headset protective sleeve × 2 pack



Microphone windscreen × 9



Headset storage bag × 9



Storage container × 1



User manual × 1

Accsoon CoMo (1 host headset, 6 remote headsets) package includes:

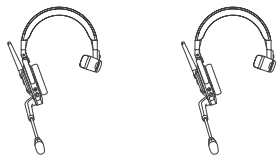

Host Headset x 1 Remote headset x 6

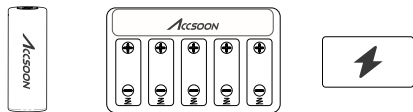

Battery x 14 Battery charger x 2 Battery storage box x 3

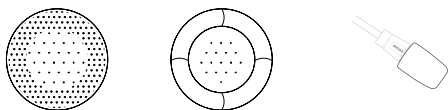

Headset ear cushion x 7 Headset protective sleeve x 2 packs Microphone windscreen x 7



Headset storage bag x 7 Storage container x 1 User manual x 1

Accsoon CoMo (1 host headset, 4 remote headsets) package includes:

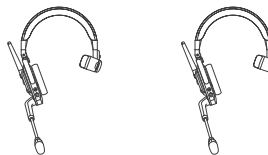

Host Headset x 1 Remote headset x 4

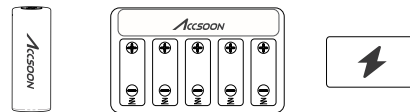

Battery x 10 Battery charger x 1 Battery storage box x 2

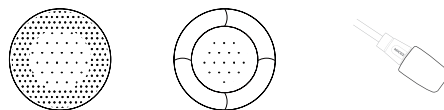

Headset ear cushion x 5 Headset protective sleeve x 1 pack Microphone windscreen x 5



Headset storage bag x 5 Storage container x 1 User manual x 1

Accsoon CoMo (1 host headset, 2 remote headsets) package includes:

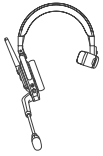

Host Headset x 1



Remote headset x 2



Battery x 6

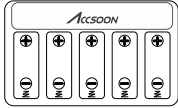

Battery charger x 1



Battery storage box x 1

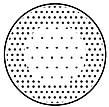

Headset ear cushion x 3

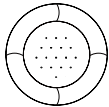

Headset protective sleeve x 1 pack



Microphone windscreen x 3



Headset storage bag x 3



Storage container x 1



User manual x 1

Accsoon CoMo (Single headset) package includes:

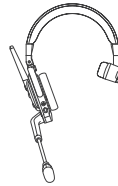

Headset x 1



Battery x 2



User manual x 1

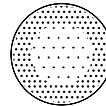

Headset ear cushion x 1



Microphone windscreen x 1

2.Product Description

Thank you for choosing the Accsoon CoMo — A full-duplex wireless intercom system.

Accsoon CoMo is equipped with Accsoon stability, seamlessly supporting communication for teams of up to 9 people. With its all-new product design and enhancements from ENC technology, the Accsoon CoMo, with no need of base station, can provide a 400-meter (1312 ft) line of sight connection range and over 10 hours of noise-free communication experience. The Accsoon CoMo could be your perfect team communication solution for added convenience and better connectivity.

3.Product Features

- Flip-to-mute microphone
- 10+ hours of extended battery life
- Environmental noise cancellation(ENC)
- 1312ft line of sight transmission range
- Full duplex real-time audio communication
- 1 host headset can support up to 8 remote headsets
- Industry leading wireless stability for easier real time communication
- Ergonomic headset design, compatible for both left ear and right ear wearing
- Simply power on for immediate use, rebuild connection automatically after signal loss

4.Instruction

Accsoon CoMo

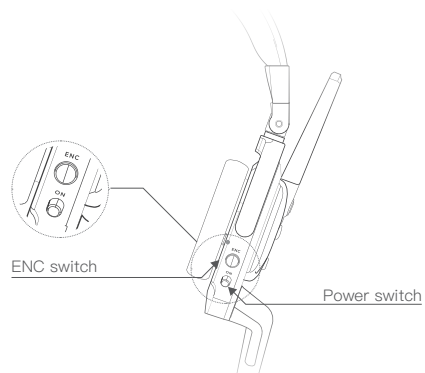
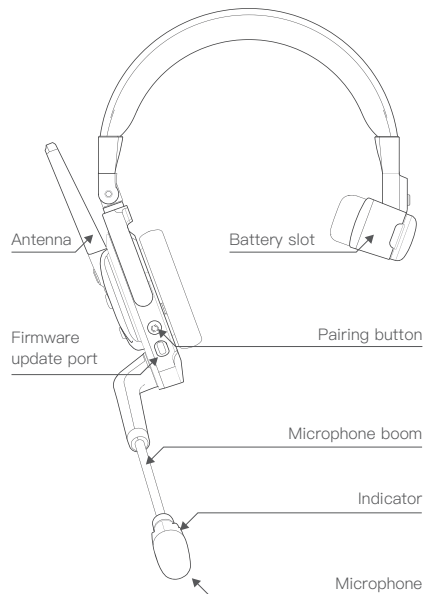
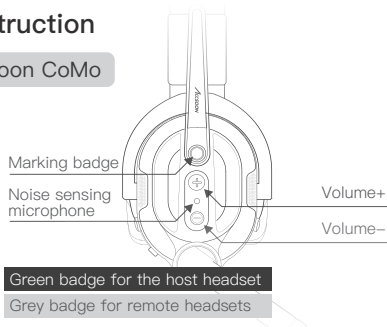

First use

STEP 1

As the picture shown, open the battery slot and put in the battery.

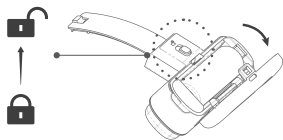

STEP 2

Push the host and remote headsets' power switch to "ON," the headset will be powered on and play "Power On" voice prompt. Indicator will show a slow green flicker.

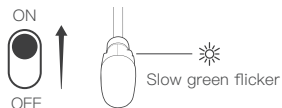

STEP 3

Headset connection

- Host and remote headsets are pre-paired in default. The headsets will automatically start connecting when powered on.
- The remote headsets will play "Connected" voice prompt once successfully connected to the host headset.

STEP 4

Turn on the microphone

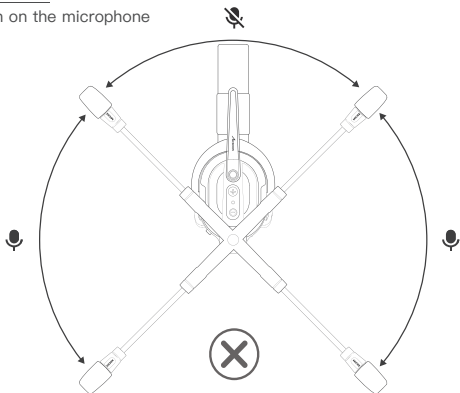

·As the picture shown, when the microphone boom is placed at 55°, the indicator will remain on with red light and the microphone is muted.

·To turn on the microphone, push the microphone boom forward to 55° the indicator will remain on with a green light.

·You will hear a "Toot" voice prompt, when the microphone is turned on/off.

Note: Maximum swivel angle of the boom axle is 115°.

Volume control

1.Push the volume "+" or "-" button on the side of the headset to turn the volume up or down.

2.The volume "+" or "-" button on the headsets can only be used for hearing volume control, not the microphone volume nor the sound effect.

3.The headsets have 7-level adjustable volumes, and is initially set to level 4. The headset can remember the last setting of the volume level.

4.The environmental noise cancellation (ENC) is set to be ON by default when the headset's powered on. You can manually turn off the ENC mode by clicking the ENC switch button.

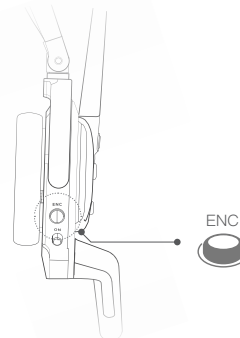

Indicator status and voice prompt

Manual Instruction	Indicator	Voice Prompt
Push the power switch to "ON"	Disconnected: Slow green flicker Connected: Green light stays on	Power On
Push the power switch to "OFF"	Indicator off	Power Off
Lift up the mic boom: Mic mute on Put down the mic boom: Mic mute off	Mute on: Red light stays on Mute off: Green light stays on	Toot
Connection success	Indicator stays on (light color follows microphone status)	Connected
Connection drops	Slow green flicker	Disconnected (Remote headset only)
Pairing	Fast green flicker	Pairing
Pairing success	Indicator stays on (light color follows microphone status)	Pairing success
Press the "ENC" Button	/	ENC On: Noise Cancelling On ENC Off: Noise Cancelling Off
Battery Level lower than 10%	Slow red flicker	Battery Level Low

5.Specifications

Label	Description
Communication Range	1312ft / 400m (with no barriers and interference))
Battery Capacity	2320 mAh (single battery)
Operating Time	Remote headset: 13 hour Host headset: 10 hour (4 remotes in connection) Host headset: 8 hour (8 remotes in connection)
Signal-to-noise Ratio	>65dB
Microphone Type	Electret
Communication Sampling Rate	16KHz/16bit (8 remotes in connection)
Weight	170g (single headset with battery)
Size	241.8 x 231.5 x 74.8 mm (single headset)
Operating Temperature	-15~45°C

6.FAQ

Connection drops

1.If the host headset was powered off, or the distance between host and remote headsets is too far, the remote headsets will be disconnected from the host, and the indicators on the remote headsets will turn into slow green flickers and play **“Disconnected”** voice prompt.

2.When the remote headsets are disconnected from the host headset, you can reconnect the headsets by powering on the host headset or put the host and remote headsets back into the communication distance, the remote headsets will automatically reconnect to the host headset. Remote headsets' indicator will stay on with green light and will play **“Connected”** voice prompt.

Pairing and host headset memory clearing

Pairing

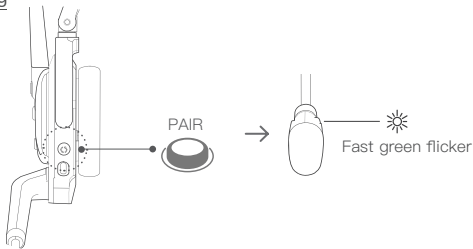

1. Switch the power button on both the host and remote headsets to **“ON”**.
2. Press and hold the pairing button on the host headset for 3 seconds to enter pairing mode. The indicator will show fast green flickers, with no prompt voice.
3. Press and hold the pairing button on remote headsets for 3 seconds to enter pairing mode. The remote headsets will play **“Pairing”** voice prompt, and the indicator will show fast green flickers.
4. If the pairing succeed, remote headsets will play **“Pairing success”** voice prompt and the indicator will show slow green flickers.
5. Please press and hold the pairing button on the host headset for 3 seconds to exit pairing.

Note: Please ensure you exit pairing mode before using Accsoon CoMo for communication.

Memorize pairing information



1. One host headset can connect and memorize 8 remote headsets at the maximum. If your host headset's memory isn't fully used, you can follow previous guideline to pair and add new remote headset(s).
2. A single remote headset can only store pairing information of one host headset at a time. To pair it with a new host headset, please follow the instructions in previous guideline to clear the remote headset's pairing memory and then pair it with the new host headset.

Note: If you have multiple Accsoon CoMo host and/or remote headsets, follow previous guideline to arrange the pairing memory of each host/remote group. Two separate groups of Accsoon CoMo can work in the same place without interference.

Pairing overtime

The pairing mode will last for 120s. The headsets will automatically exit pairing mode.If host/remote headsets are unable to pair up within the time limit, follow previous guideline to restart pairing.

Pairing memory clearing

If your host headset has already memorized 8 remote headsets, to replace the remote headsets, please follow the steps below to clear the existing pairing memory.

1. Switch your host headset power switch to **“ON”**.
2. Press and hold both the volume up **“+”** and down **“-”** button for 3 seconds. The host headset's indicator will alternately flash red and green lights, indicating that the host headset has entered the memory clearing process
3. Once the pairing memory is fully cleared, the host headset's indicator will change to slow green flickers.

Note: You only need to execute the pairing memory clearing process on the host headset. After you fully cleared the memory of the host headsets, please follow previous guideline to pair up the host and remote headsets, The new pairing information will be automatically memorized after successful pairing.

7.Warranty

Warranty period

1. If product quality related issues occur within 15 days of receiving the product, Accsoon provides complimentary maintenance or replacement.
2. Under proper use and maintenance, from the date of receipt, Accsoon provides a one-year warranty on the main product (headset, battery charger) and a three-month warranty on the battery. Free maintenance service is available during the warranty period.
3. Please keep the proof of purchase and the user manual.

Warranty exclusion

1. Out of warranty period (If the proof of purchase is unavailable, the warranty will be calculated from the date the product is delivered from the manufacturer).
2. Damage caused by use or maintenance of not following the requirements of the user manual.
3. Accessories not covered by warranty (ear cushions, windscreens, headset sleeves, storage bags and containers).
4. Unauthorized repair, modification or disassembly.
5. Damage caused by force majeure such as fire, flood, lightning strike, etc.

8.After sales

1. Please contact your local Accsoon authorized dealers for after-sales service. When there is no authorized dealer available in your region, you can contact Accsoon through email at support@accsoon.com or contact our customer service through our website (www.accsoon.com).
2. You can get detailed solutions from authorized dealers or Accsoon.
3. Accsoon reserves the right to review the damaged product.

9.Safety information

1. When operating this equipment, read and follow all the instructions in this manual.
2. Use only accessories/batteries/chargers specified or recommended by Accsoon.
3. Do not expose to moisture, excessive heat or fire.
4. Keep away from water and other liquids.
5. Keep the equipment properly during lightning storms or when unused for long periods of time.
6. Please do not use the product in a place overheating, under cooling or with lots of moisture, or nearby strong magnetic devices.
7. To reduce the risk of fire or electric shock, refer servicing to qualified service personnel.

Contact Us



Facebook: Accsoon



Facebook Group: Accsoon Official User Group



Instagram: [accsoontech](https://www.instagram.com/accsoontech)



YouTube: ACCSOON



Email: Support@accsoon.com

Federal Communication Commission Interference Statement

This device complies with part 15 of the FCC Rules. Operation is subject to the following two conditions:

- (1) This device may not cause harmful interference, and
- (2) this device must accept any interference received, including interference that may cause undesired operation.

Any Changes or modifications not expressly approved by the party responsible for compliance could void the user's authority to operate the equipment.

This equipment has been tested and found to comply with the limits for a Class B digital device, pursuant to Part 15 of the FCC Rules. These limits are designed to provide reasonable protection against harmful interference in a residential installation. This equipment generates, uses and can radiate radio frequency energy and, if not installed and used in accordance with the instructions, may cause harmful interference to radio communications. However, there is no guarantee that interference will not occur in a particular installation. If this equipment does cause harmful interference to radio or television reception, which can be determined by turning the equipment off and on, the user is encouraged to try to correct the interference by one or more of the following measures:

- Reorient or relocate the receiving antenna
- Increase the separation between the equipment and receiver.
- Connect the equipment into an outlet on a circuit different from that to which the receiver is connected.
- Consult the dealer or an experienced radio/TV technician for help.

This equipment complies with FCC radiation exposure limits set forth for an uncontrolled environment. This equipment should be installed and operated with minimum distance 20cm between the radiator & your body.

Operations in the 5.15–5.25GHz and 5.25–5.35GHz band are restricted to indoor usage only.

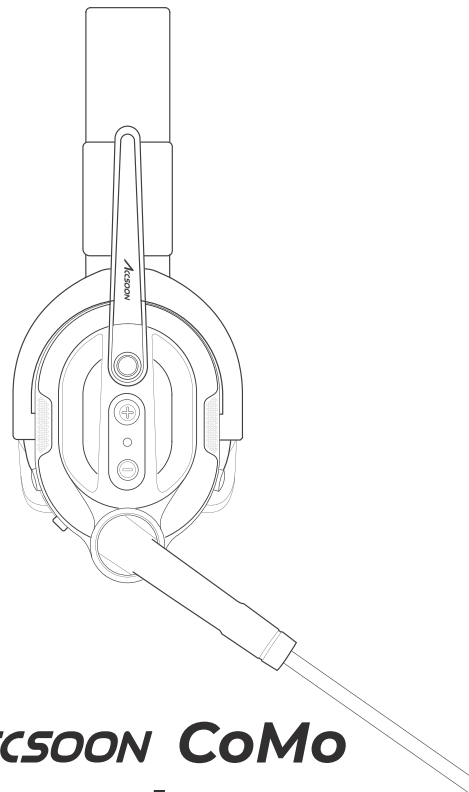

Accsoon CoMo

讯声

User Manual
用户手册

一、包装内容

讯声（一拖八）包装内含：



主控耳机 × 1

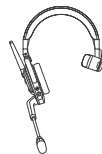

从属耳机 × 8



电池 × 18

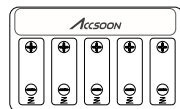

充电器 × 2



电池收纳盒 × 3

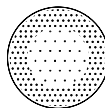

耳机海绵套 × 9

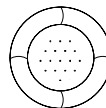

可替换耳罩保护套 × 2 包



麦克风海绵套 × 9



单耳机收纳袋 × 9



收纳箱 × 1



用户手册+保修卡 × 1

讯声（一拖六）包装内含：



主控耳机 × 1



从属耳机 × 6



电池 × 14

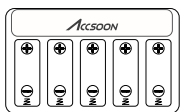

充电器 × 2



电池收纳盒 × 3

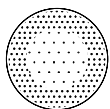

耳机海绵套 × 7

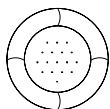

可替换耳罩保护套 × 2 包



麦克风海绵套 × 7



单耳机收纳袋 × 7

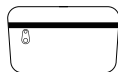

收纳箱 × 1



用户手册 + 保修卡 × 1

讯声（一拖四）包装内含：

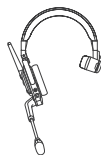

主控耳机 × 1

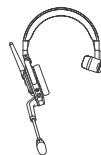

从属耳机 × 4



电池 × 10

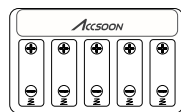

充电器 × 1



电池收纳盒 × 2

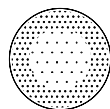

耳机海绵套 × 5

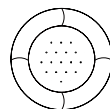

可替换耳罩保护套 × 1 包



麦克风海绵套 × 5



单耳机收纳袋 × 5



收纳包 × 1



用户手册 + 保修卡 × 1

讯声（一拖二）包装内含：



主控耳机 × 1

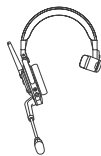

从属耳机 × 2



电池 × 6

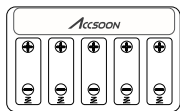

充电器 × 1



电池收纳盒 × 1

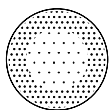

耳机海绵套 × 3

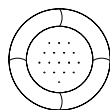

可替换耳罩保护套 × 1 包



麦克风海绵套 × 3



单耳机收纳袋 × 3



收纳盒 × 1



用户手册 + 保修卡 × 1

讯声（单只）补充耳机

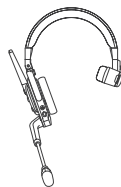

耳机 × 1



电池 × 2



用户手册 + 保修卡 × 1

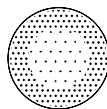

耳机海绵套 × 1



麦克风海绵套 × 1

二、产品简述

感谢您购买致迅 MIC02 全双工无线降噪对讲耳机系统

MIC02 是致迅推出的一款革新性无线对讲系统，融入了环境噪音消除 (ENC) 技术。MIC02 摆脱了对传统中心基站的依赖，实现了主控耳机与最多八个从属耳机的全双工通话，让沟通更加自由、高效。通过独特的外置天线设计，确保在高达 400 米的可视距离内，提供长达 10 小时的清晰音频交互通讯。无论是户外探险，还是团队协作，MIC02 都是您稳定可靠的通讯解决方案。

三、产品特征

- 稳定可靠信号传输
- 全双工实时通话
- 400 米可视距离信号传输
- 开机即用，自动重连
- 环境噪音消除 (ENC)
- 最高支持一主八从通话
- 左右耳兼容佩戴设计
- 麦克风通话拨杆式开关
- 主从耳机 10h 续航

四、使用说明

认识产品

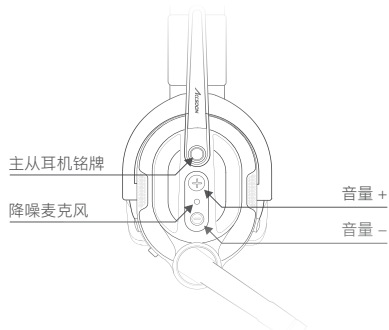

主耳机铭牌为绿色

从耳机铭牌为灰色

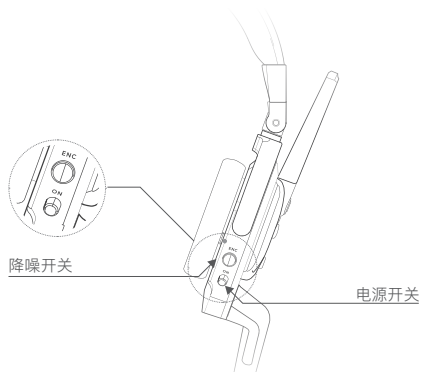
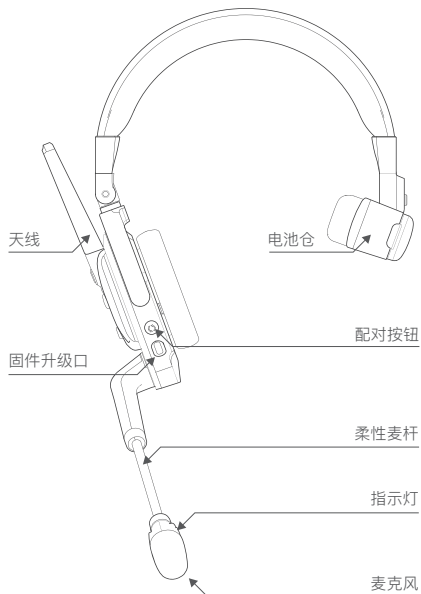

使用

STEP 1

如图所示，拨动开关解锁，打开电池仓，装配电池。

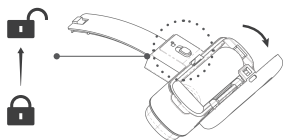

STEP 2

拨动主从耳机电源开关至 ON，耳机开机发出提示音“开机”，此时主从耳机指示灯均绿灯慢闪。

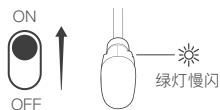

STEP 3

打开主从耳机配对连接。

- 主从耳机连接，出厂时当前主控耳机与从属耳机为已配对状态。
- 从机发出“连接成功”提示音，表示主从耳机已连接。

STEP 4

静音 / 通话

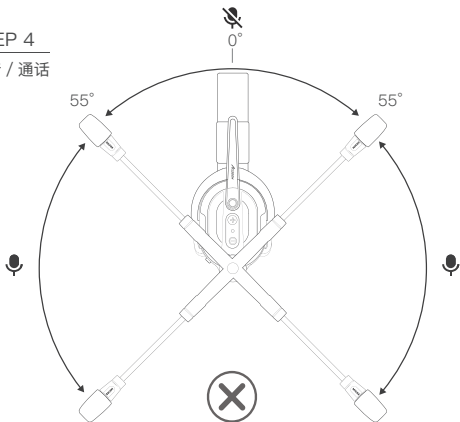

·如图所示，麦杆处于时 $\pm 55^\circ$ 以内，麦克风为关闭状态，此时指示灯红色常亮。

·将麦杆推动至超过 55° ，麦克风为开启状态，此时指示灯绿色常亮。

·当状态切换时，耳机将发出“嘟”声提示

注 转轴的最大转动角度为 115°

声音调整

1. 按下耳机侧面的“+”“-”按键即可实现对耳机音量的调节。

2. 耳机上的“+”“-”按键仅对通话音量生效，不会影响麦克风的收音效果。如需调整麦克风收音，可直接调整麦克风与声源的距离。

3. 通话音量等级共有七档，出厂默认为第四档，耳机对音量调整具有记忆功能。

4. 开机状态下，系统默认开启通话降噪功能，可手动按下降噪切换键关闭 / 打开通话降噪功能。

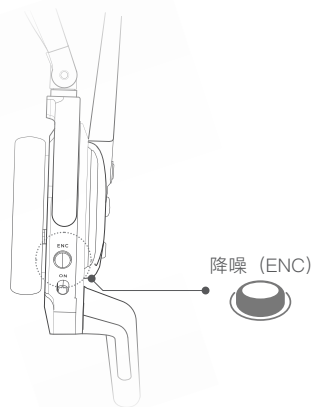

耳机状态与提示音

操作	指示灯	提示音
电源开关拨动至 ON	未连接：绿灯慢闪 已连接：绿灯常亮	开机
电源开关拨动至 OFF	指示灯熄灭	关机
抬上麦杆：静音 打下麦杆：正常	静音状态红灯常亮 通话状态绿灯常亮	“嘟”
连接完成	常亮 (颜色跟随麦杆状态)	连接成功
断连	绿灯慢闪	断连 (仅从机)
配对	绿灯持续闪烁	配对中
配对成功	常亮 (颜色跟随麦杆状态)	配对成功
单击“降噪”键，循环切换	/	降噪开启：降噪开 降噪关闭：降噪关
电量低于 10%	红灯慢闪	电量低

五、参数表格

功能 / 性能	描述
传输距离	无障碍无干扰环境下 > 400 米
电池容量	2320mAh (单节电池)
工作时间	从属耳机：约 13 小时 主控耳机：约 10 小时 (搭配 4 个从属耳机) 主控耳机：约 8 小时 (搭配 8 个从属耳机)
信噪比	>65dB
麦克风类型	驻极体
通话采样率	16KHz/16bit (一拖八情况下)
自重	170g (单只耳机带电池) 预估重量，开模样机后确认
尺寸	241.8 × 231.5 × 74.8 mm (单只耳机)
工作温度	-15~45° C

六、常见问题

断连与恢复连接

1. 若主控耳机电源关闭，或从属耳机超出主控耳机传输范围，则会发生断连状况，此时从属耳机指示灯由绿灯常亮转绿灯慢闪，耳机发出断连提示：“断连”。
2. 若当前主从耳机已经断连，可依据当前断连形态，采取主控耳机开机，或将主从耳机恢复到正确通讯距离以重新恢复通信。此时主从耳机将自动连接，从属耳机指示灯由绿灯慢闪恢复为绿灯常亮，耳机发出连接提示音：“连接成功”。

配对与清码

配对

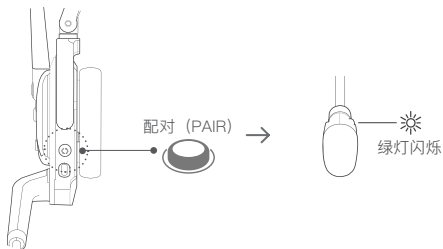

1. 拨动主控耳机电源开关至“ON”，使所需配对的主从耳机开机。
 2. 长按主控耳机的“配对”按键3秒，主控耳机进入配对状态，指示灯绿色快速闪烁，无提示声音。
 3. 长按从属耳机的“配对”按键3秒，从属耳机进入配对状态，指示灯绿色快速闪烁，发出“配对中”提示音。
 4. 从属耳机发出“配对成功”提示音，表明从属耳机和当前主控耳机配对成功，从属耳机指示灯绿灯慢闪。
 5. 主从耳机配对完毕后，短按主控耳机配对键，主从耳机均会退出配对状态。
- 注** 如需使用 Mic02 通话，请确认当前耳机均已退出配对状态。

配对记忆



1. 主控耳机至多与八台从属耳机配对。若当前主控耳机处于未满载状态，此时可按配对操作完成匹配与记忆，新配对的从属耳机不影响先前从属耳机的连接状态。
2. 从属耳机只能记忆一台主控耳机的信息。若需重新配对请按照配对部分所作说明操作。

注 如您购买了新的主控耳机，可对当前 MIC02 套装进行分配操作。从属耳机可按照配对部分所作说明进行自由分配，多套主从耳机系统可在一个场景下同时使用。

配对超时

配对状态时限为 120 秒，配对时限内若未完成配对，耳机将自动退出配对状态，指示灯变为绿灯慢闪。如需重新配对，请按照配对部分所作说明继续配对动作。

清除配对与重新配对

一台主控耳机最多可以记录八台从属耳机的配对信息。当主控耳机已经记录八台从属耳机配对信息后，如果需要将新的从属耳机与该主机进行配对，则需要清除主控耳机原有的配对信息，再依次对所需使用的从机进行重新配对。

- 拨动主控耳机电源开关至“ON”开机，此时主控耳机指示灯状态为绿灯慢闪。
- 同时长按主控耳机的音量“+”和音量“-”3秒，主控耳机指示灯呈红绿交替快闪，进入配对清除状态。
- 当主机指示灯转为绿色慢闪状态，表明配对清除成功。

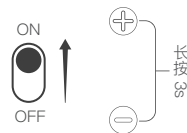

注 主机的配对清除与从机是否开机无关，主机完成清除动作后，从机开机后会立即进入等待连接状态，指示灯为绿灯慢闪，此时请按照配对部分所作说明，对所需使用的主从耳机进行重新配对，连接成功后会自动更新配对信息。

七、质保说明

质保期限

1. 自签收之日起 15 日内, 出现质量问题, 可享受退换货或者免费维修服务。
2. 产品在正确使用及保养下, 主体产品 (耳机, 充电器) 保修期为自签收之日起 1 年, 电池保修期为 3 个月, 产品在保修期内可享受免费维修服务。
3. 请妥善保管好购买凭证、说明书。

质保不包括

1. 超过三包有效期的 (无法提供购买凭证的从产品出厂日期开始计算)。
2. 未按产品使用说明书要求使用、维护、保养造成损坏的。
3. 未在质保范围内的附件 (配套耳罩、咪头罩、一次性耳罩、收纳袋以及收纳包 / 箱)。
4. 未经授权的维修、拆解。
5. 因火灾、水灾、雷击等不可抗力造成的损坏。

八、售后说明

1. 如产品需要售后, 可联系当地致讯授权经销商, 如无当地授权经销商可以通过致讯公司邮箱 (support@accsoon.com) 或网站 (www.accsoon.cn) 与客服取得联系并获得相应支持。
2. 致讯经销商或致讯客服会告知您如何运送相关产品及如何处理您的保修问题, 致讯公司保留复查损坏产品的权利。

九、安全信息

1. 操作本设备时, 请阅读并遵循本手册中的所有说明。
2. 只能使用 Accsoon 指定或推荐的附件 / 电池 / 充电器。
3. 不要暴露在潮湿、过热或中。
4. 远离水和其他液体。

十、联系我们



官方网站



官方客服微信



微信公众号



Bilibili

Certificate of Quality

This product is confirmed to meet quality standards and permitted for sale after strict inspection.

QC Inspector: _____



More details about the product please visit www.accsoon.com

This document is subject to change without notice.

Accsoon® is a trademark of Accsoon Technology Co., Ltd.

Copyright©2024 Accsoon. All rights reserved

合格证

本产品经严格检验符合标准，
准予销售

检验员: _____



欲了解产品全部信息

请浏览致迅科技官网：www.accsoon.cn

内容如有更新，恕不另行通知

Accsoon®是致迅的商标

Copyright©2024 致迅版权所有

Accsoon CoMo

Accsoon® is a trademark of Accsoon Technology Co.,Ltd.

Copyright © 2024 Accsoon All rights reserved

Accsoon®はAccsoonの商標です Copyright©2024

Accsoon® 是致迅科技的商标Copyright © 2024致迅科技版权所有